



## PRICE LIST REVISION MEMO

MARCH 2019

TO OUR VALUED CUSTOMERS,

**ATTACHED ARE SOME REVISIONS TO YOUR 2018/19 EURO PRICE LIST.**

PAGE 97-98	[97]	REVISION	SCHLUTER KERDI BOARD – PRICE DECREASE [BBY BRANCH ONLY]
PAGE 107-122	[ALL]	REVISION	SCHLUTER PRICE INCREASE [BBY BRANCH ONLY] SCHLUTER CHANGES TO SHOWER SYSTEM, ETC
PAGE 114-116	[ALL]	REVISION	DIAPLAS PRICE INCREASE [ALBERTA BRANCHES ONLY]
PAGE 125-126	[25]	REVISION	SCHLUTER KERDI BOARD – PRICE DECREASE [BBY BRANCH ONLY]

THE ABOVE PAGES WILL REPLACE THE EXISTING PAGES IN YOUR PRICE BOOK.

BURNABY | CALGARY | EDMONTON  
VISIT US ONLINE AT [www.eurotile.ca](http://www.eurotile.ca)

# SETTING MATERIAL





BURNABY BRANCH ONLY

## BACKER BOARDS

REVISION: MARCH 2019

Website: www.eurotile.ca

### KERDI BOARD

			PCS/BOX	SUGGESTED LIST PRICE
<b>SC-KB5/1220/1625</b>	KERDI-BOARD 48"x64"x3/16"		N/A	\$67.24 EA
<b>SC-KB9/1220/1625</b>	KERDI-BOARD 48"x64"x3/8"		"	\$70.53 EA
<b>SC-KB12/1220/1625</b>	KERDI-BOARD 48"x64"x1/2"		"	\$73.82 EA
<b>SC-KB12/1220/2440</b>	KERDI-BOARD 48"x96"x1/2"		"	\$110.71 EA
<b>SC-KB19/625/2440</b>	KERDI-BOARD 24 - 1/2"x96"x3/4"		"	\$60.52 EA
<p>Schluter-KERDI-BOARD is a multifunctional tile substrate and building panel, which can also be used for creating bonded waterproofing assemblies with tile coverings. It consists of an extruded polystyrene foam panel, with a special reinforcement material on both sides and fleece webbing for effective anchoring in thin-set mortar. Tiles can be installed directly over KERDI-BOARD using the thin-set method.</p>				
<b>SC-KB12SN305152A</b>	KERDI-BOARD-SN NICHE 12"x6"			\$56.96 EA
<b>SC-KB12SN305305A</b>	KERDI-BOARD-SN NICHE 12"x12"			\$68.22 EA
<b>SC-KB12SN305508A1</b>	KERDI-BOARD-SN NICHE 12"x20"			\$92.21 EA
<b>SC-KB12SN305711A1</b>	KERDI-BOARD-SN NICHE 12"x28"			\$110.21 EA
<p>Schluter®-KERDI-BOARD-SN is a prefabricated shower niche made of KERDI-BOARD that can be installed in both Schluter®-KERDI and KERDI-BOARD wall assemblies.</p>				
<b>SC-KBZT32Z</b>	ATTACHMENT WASHERS 1 - 1/4		100	\$10.98 EA
<p>Schluter-KERDI-BOARD-ZT are galvanized steel washers, which are used to fasten Schluter-KERDI-BOARD to stud framing. They feature tabs that penetrate the surface of the KERDI-BOARD and temporarily hold the washers in place to enable quick installation of the corresponding screws.</p>				
<b>SC-KBZS35G</b>	COURSE THREAD SCREW 1 - 5/8		200	\$14.98 EA
<b>SC-KBZS55G</b>	COURSE THREAD SCREW 2		100	\$10.98 EA
<b>SC-KBZS75G</b>	COURSE THREAD SCREW 3		100	\$16.76 EA
<p>Schluter-KERDI-BOARD-ZS are screws, which are used to fasten Schluter-KERDI-BOARD to stud framing with the corresponding washers.</p>				

# SETTING MATERIAL

## BACKER BOARDS

REVISION: JANUARY 2019

Website: [www.eurotile.ca](http://www.eurotile.ca)

### WONDERBOARD BACKERBOARD

		PCS/BOX	PCS/PALLET	LBS/ PALLET	SUGGESTED LIST PRICE
<b>WB-35</b>	3'x5' WONDERBOARD- 7/16" THICKNESS	N/A	45	1900	<b>\$37.95 EA</b>

CONVERSION: 15 SF/SHEET

The original glass mesh cement backerboard underlayment for tile and stone installations. Remains dimensionally stable, while increasing in strength, when exposed to continuous moisture. Tough and versatile for residential and commercial exterior applications or interior walls, floors, countertops and wet areas. Tapeless installation saves time. Protected by MoldGard® Technology to resist mold and mildew growth.





# MAINTENANCE PRODUCTS

TILELAB

REVISION: JANUARY 2019

Website: www.eurotile.ca

## TILELAB- FINISHING SEALERS

		PCS/BOX	LBS/BOX	SUGGESTED LIST PRICE
<b>CTLGLSS-1QT</b> 	<b>TILELAB GLOSS SEALER AND FINISH- 1 QT</b> Top-coat finish protects saltillo, terra-cotta, slate or flagstone. Resists scuffs and stains. High-gloss finish for interiors only.	6	14	<b>\$25.00 EA</b>
	<b>Tile Types:</b> Clay pavers including saltillo, terra-cotta, and adobe, cement tile, quarry tile, slate and flagstone.			
<b>CTLMTSS-1QT</b> <b>CTLMTSS-1G</b> 	<b>TILELAB MATTE SEALER AND FINISH- 1 QT</b> Top-coat finish protects saltillo, terra-cotta, slate or flagstone. Resists scuffs and stains. Matte finish can be used indoors or out.	6	14	<b>\$25.00 EA</b>
	<b>TILELAB MATTE SEALER AND FINISH- 1 GAL</b> Top-coat finish protects saltillo, terra-cotta, slate or flagstone. Resists scuffs and stains. Matte finish can be used indoors or out.	4	36	
	<b>Tile Types:</b> Clay pavers including saltillo, terra-cotta, and adobe, cement tile, quarry tile, slate and flagstone.			

# SCHLUTER PROFILES

BURNABY BRANCH ONLY

JOLLY PROFILES

REVISION: MARCH 2019

Website: www.eurotile.ca

## JOLLY JUNIOR PROFILES

		SUGGESTED LIST PRICE
BW-60J	JOLLY JUNIOR PROFILE- PVC BRIGHT WHITE: 1/4"	\$3.05 EA
BW-80J	JOLLY JUNIOR PROFILE- PVC BRIGHT WHITE: 5/16"	\$3.20 EA
BW-110J	JOLLY JUNIOR PROFILE- PVC BRIGHT WHITE: 7/16"	\$3.52 EA

\*Schluter Jolly finishes and protects outside wall corners and other tiled edges, eg., tiled skirting. The integrated spacer creates a channel for grouting the tile.

## JOLLY PROFILES

		SUGGESTED LIST PRICE
AM-60	JOLLY PROFILE- SATIN BRASS ANODIZED ALUMINUM: 1/4"	\$13.43 EA
AM-80	JOLLY PROFILE- SATIN BRASS ANODIZED ALUMINUM: 5/16"	\$13.92 EA
AM-100	JOLLY PROFILE- SATIN BRASS ANODIZED ALUMINUM: 3/8"	\$14.70 EA
BW-60	JOLLY PROFILE- PVC BRIGHT WHITE: 1/4"	\$4.36 EA
BW-80	JOLLY PROFILE- PVC BRIGHT WHITE: 5/16"	\$4.44 EA
BW-100	JOLLY PROFILE- PVC BRIGHT WHITE: 3/8"	\$4.71 EA
BW-125	JOLLY PROFILE- PVC BRIGHT WHITE: 1/2"	\$4.89 EA
SC-A60AGSG	JOLLY PROFILE- ANODIZED ALUMINUM BRIGHT BLACK: 1/4"	\$16.21 EA
SC-A80AGSG	JOLLY PROFILE- ANODIZED ALUMINUM BRIGHT BLACK: 5/16"	\$17.00 EA
SC-A100AGSG	JOLLY PROFILE- ANODIZED ALUMINUM BRIGHT BLACK: 3/8"	\$17.48 EA
SC-A125AGSG	JOLLY PROFILE- ANODIZED ALUMINUM BRIGHT BLACK: 1/2"	\$17.98 EA
SC-AK60	JOLLY PROFILE- SATIN COPPER ANODIZED ALUMINUM: 1/4"	\$14.23 EA
SC-AK80	JOLLY PROFILE- SATIN COPPER ANODIZED ALUMINUM: 5/16"	\$15.18 EA
SC-AK100	JOLLY PROFILE- SATIN COPPER ANODIZED ALUMINUM: 3/8"	\$15.69 EA
SC-AK125	JOLLY PROFILE- SATIN COPPER ANODIZED ALUMINUM: 1/2"	\$16.66 EA
SC-AKGB100	JOLLY PROFILE- BRUSHED COPPER ANODIZED ALUMINUM: 3/8"	\$18.63 EA
SC-ANI60	JOLLY PROFILE- SATIN NICKEL ANODIZED ALUMINUM: 1/4"	\$13.94 EA
SC-ANI80	JOLLY PROFILE- SATIN NICKEL ANODIZED ALUMINUM: 5/16"	\$14.61 EA
SC-ANI100	JOLLY PROFILE- SATIN NICKEL ANODIZED ALUMINUM: 3/8"	\$15.09 EA
SC-ANI125	JOLLY PROFILE- SATIN NICKEL ANODIZED ALUMINUM: 1/2"	\$16.03 EA
SC-ANIG80	JOLLY PROFILE- POLISHED NICKEL ANODIZED ALUMINUM: 5/16"	\$17.17 EA
SC-ANIG100	JOLLY PROFILE- POLISHED NICKEL ANODIZED ALUMINUM: 3/8"	\$17.65 EA
SC-ANIG125	JOLLY PROFILE- POLISHED NICKEL ANODIZED ALUMINUM: 1/2"	\$18.14 EA
SC-ANIGB80	JOLLY PROFILE- BRUSHED NICKEL ANODIZED ALUMINUM: 5/16"	\$17.30 EA
SC-ANIGB100	JOLLY PROFILE- BRUSHED NICKEL ANODIZED ALUMINUM: 3/8"	\$18.27 EA
SC-ANIGB125	JOLLY PROFILE- BRUSHED NICKEL ANODIZED ALUMINUM: 1/2"	\$19.13 EA
W-60	JOLLY PROFILE- PVC WHITE: 1/4"	\$4.36 EA
W-80	JOLLY PROFILE- PVC WHITE: 5/16"	\$4.44 EA
W-100	JOLLY PROFILE- PVC WHITE: 3/8"	\$4.71 EA

\*Schluter Jolly finishes and protects outside wall corners and other tiled edges, eg., tiled skirting. The integrated spacer creates a channel for grouting the tile.



# SCHLUTER PROFILES

BURNABY BRANCH ONLY

## DECO & QUADEC PROFILES & REMA

REVISION: MARCH 2019

Website: [www.eurotile.ca](http://www.eurotile.ca)

### DECO PROFILE

SUGGESTED  
LIST PRICE

#### SC-E125D DECO - STAINLESS STEEL: 1/2"

Schluter®-DECO is designed to provide decorative lines within tile coverings and edge protection at transitions from tile coverings to other same-height surface coverings, such as wood or carpet.

The profile is available in stainless steel, solid brass, chrome-plated solid brass, and anodized aluminum. DECO features a trapezoid-perforated anchoring leg, which is secured in the mortar bond coat beneath the tile, and a 1/4" (6 mm)-wide visible surface that meets the high aesthetic requirements of showrooms, lobbies, galleries, exhibition booths, etc.

The anchoring leg of DECO, in solid brass, chrome-plated solid brass, and anodized aluminum, is available with a special radius perforation "R" so that the profile can be used to form curves. DECO in chrome-plated brass requires a relatively large bending radius.



\$49.84 EA

### QUADEC PROFILE

SUGGESTED  
LIST PRICE

#### SC-Q60AE QUADEC PROFILE- SATIN ANODIZED ALUMINUM: 1/4"

Schluter-QUADEC is a finishing and edge-protection profile for the outside corners of tiled surfaces. It features a trapezoid-perforated anchoring leg that is secured in the mortar bond coat beneath the tile and a reveal that forms a square outer corner along the surface edge. In addition, Schluter-QUADEC is suitable for transitions, corners, or dado coverings with other covering materials; for example, carpet, parquet, natural stone tiles, or poured epoxy coverings. The integrated joint spacer forms a defined joint cavity with the tile.



\$17.08 EA

### REMA ACCESS PANELS

SUGGESTED  
LIST PRICE

#### REMA TILE MAGNET AND COUNTER PLATE (4 PCE SET)

Schluter®-REMA is the ideal system for creating concealed access panels in tiled wall coverings. REMA's installation is independent of tile size and thickness and enables exact matching of the access panel to the overall joint design. Thus, panels that access electrical or plumbing components do not impair the visual appearance of the tile covering.

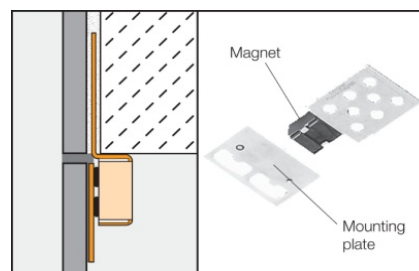

\$11.66 EA

# SCHLUTER PROFILES

BURNABY BRANCH ONLY

RENO PROFILES

REVISION: MARCH 2019

Website: [www.eurotile.ca](http://www.eurotile.ca)

## RENO T PROFILES

SUGGESTED  
LIST PRICE

**RENO-T9/14AE** RENO T PROFILE- SATIN ANODIZED ALUMINUM- 11/32"H x 9/16"W

\$11.45 EA

\*Reno T is retrofitted to adjoin different types of floor coverings of the same height.



## RENO TK PROFILES

SUGGESTED  
LIST PRICE

**AETK-80** RENO TK PROFILE- SATIN ANODIZED ALUMINUM: 5/16"  
**AETK-100** RENO TK PROFILE- SATIN ANODIZED ALUMINUM: 3/8"  
**AETK-125** RENO TK PROFILE- SATIN ANODIZED ALUMINUM: 1/2"

\$16.88 EA

\$18.43 EA

\$23.87 EA

**AMBTk-80** RENO TK PROFILE- BRIGHT BRASS ANODIZED ALUMINUM: 5/16"  
**AMBTk-100** RENO TK PROFILE- BRIGHT BRASS ANODIZED ALUMINUM: 3/8"  
**AMBTk-125** RENO TK PROFILE- BRIGHT BRASS ANODIZED ALUMINUM: 1/2"

\$19.39 EA

\$20.49 EA

\$26.03 EA

**SC-ANITK80** RENO TK PROFILE- SATIN NICKEL ANODIZED ALUMINUM: 5/16"  
**SC-ANITK100** RENO TK PROFILE- SATIN NICKEL ANODIZED ALUMINUM: 3/8"  
**SC-ANITK125** RENO TK PROFILE- SATIN NICKEL ANODIZED ALUMINUM: 1/2"

\$19.45 EA

\$23.57 EA

\$26.52 EA

\*Schluter Reno-TK provides a smooth transition between tiled surfaces and lower neighboring floor covering. In addition, the edges of the adjacent floor coverings are effectively protected.



## RENO U PROFILES

SUGGESTED  
LIST PRICE

**AEU-80** RENO U PROFILE- SATIN ANODIZED ALUMINUM: 5/16"  
**AEU-100** RENO U PROFILE- SATIN ANODIZED ALUMINUM: 3/8"  
**AEU-125** RENO U PROFILE- SATIN ANODIZED ALUMINUM: 1/2"

\$18.34 EA

\$19.32 EA

\$25.52 EA

**MU-80** RENO U PROFILE- SOLID BRASS: 5/16"  
**MU-100** RENO U PROFILE- SOLID BRASS: 3/8"

\$55.25 EA

\$62.13 EA

**SC-AU80ANI** RENO U PROFILE- SATIN NICKEL ANODIZED ALUMINUM: 5/16"  
**SC-AU100ANI** RENO U PROFILE- SATIN NICKEL ANODIZED ALUMINUM: 3/8"  
**SC-AU125ANI** RENO U PROFILE- SATIN NICKEL ANODIZED ALUMINUM: 1/2"

\$18.59 EA

\$20.40 EA

\$26.52 EA

**SC-AU80AK** RENO U PROFILE- COPPER ANODIZED ALUMINUM: 5/16"  
**SC-AU100AK** RENO U PROFILE- COPPER ANODIZED ALUMINUM: 3/8"  
**SC-AU125AK** RENO U PROFILE- COPPER ANODIZED ALUMINUM: 1/2"

\$18.59 EA

\$20.40 EA

\$26.52 EA

\*Schluter Reno-U provides a smooth transition between floor coverings of different heights.



# SCHLUTER PROFILES

BURNABY BRANCH ONLY

## RONDEC PROFILES

REVISION: MARCH 2019

Website: [www.eurotile.ca](http://www.eurotile.ca)

### RONDEC ALUMINUM PROFILES

SUGGESTED  
LIST PRICE

<b>SC-RO60AE</b>	RONDEC ALUMINUM PROFILE- SATIN ANODIZED ALUMINUM: 1/4"	<b>\$15.53 EA</b>
<b>SC-RO80AE</b>	RONDEC ALUMINUM PROFILE- SATIN ANODIZED ALUMINUM: 5/16"	<b>\$17.17 EA</b>
<b>SC-RO100AE</b>	RONDEC ALUMINUM PROFILE- SATIN ANODIZED ALUMINUM: 3/8"	<b>\$17.89 EA</b>
<b>SC-RO60ACG</b>	RONDEC PROFILE- POLISHED CHROME ANODIZED ALUMINUM: 1/4"	<b>\$17.77 EA</b>
<b>SC-RO80ACG</b>	RONDEC PROFILE- POLISHED CHROME ANODIZED ALUMINUM: 5/16"	<b>\$18.85 EA</b>
<b>SC-RO60AMG</b>	RONDEC PROFILE- POLISHED BRASS ANODIZED ALUMINUM: 1/4"	<b>\$17.94 EA</b>
<b>SC-RO80AMG</b>	RONDEC PROFILE- POLISHED BRASS ANODIZED ALUMINUM: 5/16"	<b>\$19.04 EA</b>

Schluter®-RONDEC is a finishing and edge-protection profile for tiled edges and outside corners of tiled surfaces. The reveal of the profile forms a symmetrically rounded corner along the surface edge.





# SCHLUTER PROFILES

BURNABY BRANCH ONLY

## RONDEC STEP PROFILES

REVISION: MARCH 2019

Website: [www.eurotile.ca](http://www.eurotile.ca)

### RONDEC STEP ALUMINUM PROFILES (1-1/2" EDGING LENGTH)

		SUGGESTED LIST PRICE
SC-RS100ABGB39	RONDEC STEP - BRUSHED ANTIQUE BRONZE ANODIZED ALUMINUM: 3/8"	\$54.88 EA
SC-RS100AE39	RONDEC STEP ANODIZED ALUMINUM- SATIN ALUMINUM: 3/8"	\$42.60 EA
SC-RS80AT39	RONDEC STEP ANODIZED ALUMINUM- SATIN NICKEL: 5/16"	\$41.91 EA

### RONDEC STEP ALUMINUM PROFILES (2-1/4" EDGING LENGTH)

		SUGGESTED LIST PRICE
SC-RS80ACGB57	RONDEC STEP ANODIZED ALUMINUM- BRUSHED CHROME: 5/16"	\$54.84 EA
SC-RS80AE57	RONDEC STEP ANODIZED ALUMINUM- SATIN ALUMINUM: 5/16"	\$42.77 EA
SC-RS100AE57	RONDEC STEP ANODIZED ALUMINUM- SATIN ALUMINUM: 3/8"	\$43.47 EA
SC-RS125AE57	RONDEC STEP ANODIZED ALUMINUM- SATIN ALUMINUM: 1/2"	\$45.43 EA
SC-RS80AK57	RONDEC STEP ANODIZED ALUMINUM- SATIN COPPER: 5/16"	\$42.77 EA
SC-RS100AK57	RONDEC STEP ANODIZED ALUMINUM- SATIN COPPER: 3/8"	\$43.47 EA
SC-RS80AM57	RONDEC STEP ANODIZED ALUMINUM- SATIN BRASS: 5/16"	\$42.77 EA
SC-RS100AM57	RONDEC STEP ANODIZED ALUMINUM- SATIN BRASS: 3/8"	\$43.47 EA
SC-RS80AMGB57	RONDEC STEP ANODIZED ALUMINUM- BRUSHED BRASS: 5/16"	\$54.84 EA

Schluter®-RONDEC-STEP is a finishing and edging profile for ceramic tile and dimension stone installations on countertops and stairs. The top of the profile features a symmetrically rounded edge that matches the RONDEC profile, while the vertical leg of the profile hides the exposed edge of the sub-assembly.



# SCHLUTER PROFILES

BURNABY BRANCH ONLY

## SCHIENE PROFILES

REVISION: MARCH 2019

Website: www.eurotile.ca

### SCHIENE BASIC PROFILES

		SUGGESTED LIST PRICE
SC-ABA80AE	SCHIENE BASIC PROFILE- SATIN ALUMINUM: 5/16"	\$9.10 EA
SC-ABA100AE	SCHIENE BASIC PROFILE- SATIN ALUMINUM: 3/8"	\$9.53 EA
SC-ABA125AE	SCHIENE BASIC PROFILE- SATIN ALUMINUM: 1/2"	\$9.90 EA
SC-ABA80AT	SCHIENE BASIC PROFILE- SATIN NICKEL ALUMINUM: 5/16"	\$11.34 EA
SC-ABA100AT	SCHIENE BASIC PROFILE- SATIN NICKEL ALUMINUM: 3/8"	\$11.72 EA
SC-ABA125AT	SCHIENE BASIC PROFILE- SATIN NICKEL ALUMINUM: 1/2"	\$12.44 EA

\*SCHIENE-BASIC is an edge-protection profile for tile coverings without an integrated joint spacer. This profile is available in 2.5 m (8' 2-1/2") or 2.75 m (9') lengths.

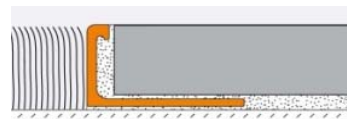

### SCHIENE PROFILES

		SUGGESTED LIST PRICE
ACB-60	SCHIENE PROFILE- BRIGHT CHROME ANODIZED ALUMINUM: 1/4"	\$13.38 EA
ACB-80	SCHIENE PROFILE- BRIGHT CHROME ANODIZED ALUMINUM: 5/16"	\$13.88 EA
ACB-100	SCHIENE PROFILE- BRIGHT CHROME ANODIZED ALUMINUM: 3/8"	\$14.17 EA
ACB-125	SCHIENE PROFILE- BRIGHT CHROME ANODIZED ALUMINUM: 1/2"	\$14.66 EA
AE-60	SCHIENE PROFILE- SATIN ANODIZED ALUMINUM: 1/4"	\$11.57 EA
AE-80	SCHIENE PROFILE- SATIN ANODIZED ALUMINUM: 5/16"	\$11.71 EA
AE-100	SCHIENE PROFILE- SATIN ANODIZED ALUMINUM: 3/8"	\$12.28 EA
AE-125	SCHIENE PROFILE- SATIN ANODIZED ALUMINUM: 1/2"	\$12.75 EA
AE-150	SCHIENE PROFILE- SATIN ANODIZED ALUMINUM: 9/16"	\$14.18 EA

\*The Schiene profile finishes & protects the edges of tiled surfaces. Can also be used in conjunction with other covering materials and applications.

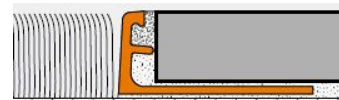

### SCHIENE E PROFILES

		SUGGESTED LIST PRICE
SC-E60	SCHIENE E PROFILE- STAINLESS STEEL: 1/4"	\$39.06 EA
SC-E80	SCHIENE E PROFILE- STAINLESS STEEL: 5/16"	\$40.59 EA
SC-E100	SCHIENE E PROFILE- STAINLESS STEEL: 3/8"	\$42.83 EA
SC-E125	SCHIENE E PROFILE- STAINLESS STEEL: 1/2"	\$44.26 EA

\*Schluter Schiene-E is roll-formed from stainless steel. This process produces a contour that deviates slightly from the extruded brass and aluminum versions. Schluter Schiene-E can withstand high levels of mechanical stress, and is especially suited for areas of application where resistance to chemical and acids is necessary (for example, the food industry, breweries, dairies, large kitchens, swimming pools).

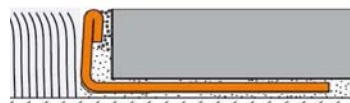

# DIAPLAS TILE TRIM

CALGARY & EDMONTON BRANCHES ONLY

L SHAPED PROFILES

REVISION: MARCH 2019

Website: [www.eurotile.ca](http://www.eurotile.ca)

## L SHAPED PROFILES

		SUGGESTED LIST PRICE
<b>DIA-040-60</b>	L SHAPED PROFILE - PVC IVORY: 6MM (1/4")	\$3.70 EA
<b>DIA-040-80</b>	L SHAPED PROFILE - PVC IVORY: 8MM (5/16")	\$3.70 EA
<b>DIA-111-80</b>	L SHAPED PROFILE - NATURAL (MILL FINISH): 8MM (5/16")	\$8.95 EA
<b>DIA-111-100</b>	L SHAPED PROFILE - NATURAL (MILL FINISH): 10MM (3/8")	\$9.50 EA
<b>DIA-111-125</b>	L SHAPED PROFILE - NATURAL (MILL FINISH): 12.5MM (1/2")	\$9.80 EA
<b>DIA-136-60</b>	L SHAPED PROFILE - PVC WHITE: 6MM (1/4")	\$3.70 EA
<b>DIA-136-80</b>	L SHAPED PROFILE - PVC WHITE: 8MM (5/16")	\$3.70 EA
<b>DIA-136-100</b>	L SHAPED PROFILE - PVC WHITE: 10MM (3/8")	\$4.10 EA
<b>DIA-222-60</b>	L SHAPED PROFILE - SATIN ANODIZED: 6MM (1/4")	\$10.50 EA
<b>DIA-222-80</b>	L SHAPED PROFILE - SATIN ANODIZED: 8MM (5/16")	\$10.65 EA
<b>DIA-222-100</b>	L SHAPED PROFILE - SATIN ANODIZED: 10MM (3/8")	\$10.95 EA
<b>DIA-222-125</b>	L SHAPED PROFILE - SATIN ANODIZED: 12.5MM (1/2")	\$11.50 EA
<b>DIA-222-150</b>	L SHAPED PROFILE - SATIN ANODIZED: 15MM (5/8")	\$12.50 EA
<b>DIA-223-60</b>	L SHAPED PROFILE - BRIGHT ANODIZED: 6MM (1/4")	\$11.85 EA
<b>DIA-223-80</b>	L SHAPED PROFILE - BRIGHT ANODIZED: 8MM (5/16")	\$12.50 EA
<b>DIA-223-100</b>	L SHAPED PROFILE - BRIGHT ANODIZED: 10MM (3/8")	\$12.95 EA
<b>DIA-223-125</b>	L SHAPED PROFILE - BRIGHT ANODIZED: 12.5MM (1/2")	\$13.60 EA
<b>DIA-250-80</b>	L SHAPED PROFILE - LIGHT BRONZE ANODIZED: 8MM (5/16")	\$13.60 EA
<b>DIA-250-100</b>	L SHAPED PROFILE - LIGHT BRONZE ANODIZED: 10MM (3/8")	\$14.25 EA
<b>DIA-250-125</b>	L SHAPED PROFILE - LIGHT BRONZE ANODIZED: 12.5MM (1/2")	\$14.75 EA
<b>DIA-275-80</b>	L SHAPED PROFILE - DARK BRONZE ANODIZED: 8MM (5/16")	\$13.60 EA
<b>DIA-275-100</b>	L SHAPED PROFILE - DARK BRONZE ANODIZED: 10MM (3/8")	\$14.25 EA
<b>DIA-275-125</b>	L SHAPED PROFILE - DARK BRONZE ANODIZED: 12.5MM (1/2")	\$14.75 EA
<b>DIA-333-80</b>	L SHAPED PROFILE - SATIN BRASS ANODIZED: 8MM (5/16")	\$12.50 EA
<b>DIA-333-100</b>	L SHAPED PROFILE - SATIN BRASS ANODIZED: 10MM (3/8")	\$12.95 EA
<b>DIA-555-80</b>	L SHAPED PROFILE - BLACK ANODIZED: 8MM (5/16")	\$13.50 EA
<b>DIA-555-100</b>	L SHAPED PROFILE - BLACK ANODIZED: 10MM (3/8")	\$14.50 EA
<b>DIA-777-80</b>	L SHAPED PROFILE - WHITE PAINT: 8MM (5/16")	\$14.95 EA
<b>DIA-777-100</b>	L SHAPED PROFILE - WHITE PAINT: 10MM (3/8")	\$15.75 EA
<b>DIA-777-125</b>	L SHAPED PROFILE - WHITE PAINT: 12.5MM (1/2")	\$16.50 EA
<b>DIA-850-60</b>	L SHAPED PROFILE - SATIN NICKEL ANODIZED: 6MM (1/4")	\$12.50 EA
<b>DIA-850-80</b>	L SHAPED PROFILE - SATIN NICKEL ANODIZED: 8MM (5/16")	\$13.50 EA
<b>DIA-850-100</b>	L SHAPED PROFILE - SATIN NICKEL ANODIZED: 10MM (3/8")	\$13.85 EA
<b>DIA-850-125</b>	L SHAPED PROFILE - SATIN NICKEL ANODIZED: 12.5MM (1/2")	\$14.75 EA
<b>DIA-888-80</b>	L SHAPED PROFILE - BRIGHT NICKEL ANODIZED: 8MM (5/16")	\$14.50 EA
<b>DIA-888-100</b>	L SHAPED PROFILE - BRIGHT NICKEL ANODIZED: 10MM (3/8")	\$15.25 EA
<b>DIA-888-125</b>	L SHAPED PROFILE - BRIGHT NICKEL ANODIZED: 12.5MM (1/2")	\$16.00 EA
<p>"L-Shaped" tile trims are used to protect and embellish any angle or endings of ceramic tile lay-outs where tile edges are not secure by grout joints and where a professional and luxury finish is desired. This profile will prevent tile edges from chipping while providing a finished bumping edge for other flooring materials.</p>		
<b>DIA-EC222-80</b>	ECONOMY L SHAPED PROFILE - SATIN ANODIZED: 8MM (5/16")	\$7.95 EA
<b>DIA-EC222-100</b>	ECONOMY L SHAPED PROFILE - SATIN ANODIZED: 10MM (3/8")	\$8.25 EA
<b>DIA-EC222-125</b>	ECONOMY L SHAPED PROFILE - SATIN ANODIZED: 12.5MM (1/2")	\$8.70 EA



Aluminum Economic "L-Shaped" tile trims are used to protect and embellish any angle or endings of ceramic tile lay-outs for a fraction of the price of the regular satin and satin nickel anodized moulding. This extrusion has been designed thinner than our regular range to reduce cost.

# DIAPLAS TILE TRIM

CALGARY & EDMONTON BRANCHES ONLY

TRANSITION & T SHAPED PROFILES

REVISION: MARCH 2019

Website: [www.eurotile.ca](http://www.eurotile.ca)

## CARPET TRANSITION PROFILES

		SUGGESTED LIST PRICE
<b>DIA-CT222-80</b>	CARPET TRANSITION PROFILE - SATIN ANODIZED: 8MM (5/16")	\$15.50 EA
<b>DIA-CT222-100</b>	CARPET TRANSITION PROFILE - SATIN ANODIZED: 10MM (3/8")	\$16.95 EA
<b>DIA-CT222-125</b>	CARPET TRANSITION PROFILE - SATIN ANODIZED: 12.5MM (1/2")	\$21.50 EA
<b>DIA-CT223-100</b>	CARPET TRANSITION PROFILE - BRIGHT ANODIZED: 10MM (3/8")	\$18.95 EA
<b>DIA-CT850-80</b>	CARPET TRANSITION PROFILE - SATIN NICKEL ANODIZED: 8MM (5/16")	\$17.95 EA
<b>DIA-CT850-100</b>	CARPET TRANSITION PROFILE - SATIN NICKEL ANODIZED: 10MM (3/8")	\$21.50 EA
<b>DIA-CT850-125</b>	CARPET TRANSITION PROFILE - SATIN NICKEL ANODIZED: 12.5MM (1/2")	\$23.95 EA

The specificity of this moulding is to facilitate the juxtaposition from a ceramic tile surface to a carpeted area. This trim allows you the possibility to insert the carpet in a way to avoid the fraying out of the chosen floor covering. So, it increases the efficiency and durability of your work. A fine way to join practical and esthetically good looking results.



## T SHAPED PROFILES

		SUGGESTED LIST PRICE
<b>DIA-TT222</b>	T SHAPE PROFILE - SATIN ANODIZED: 20MM (13/16")	\$10.50 EA
<b>DIA-TT850</b>	T SHAPE PROFILE - SATIN NICKEL ANODIZED: 20MM (13/16")	\$12.85 EA

Their primary use is to create a joint cover between two floor surfaces of the same height already installed where expansion is expected. The curved end on each side of this profile has been designed to create a transition between the two floors if they are not perfectly the same height. This avoids creating an empty space between the trim and the floor. Often used to separate two rooms or to delimit two floors for example hardwood and ceramic.



## TRANSITION PROFILES

		SUGGESTED LIST PRICE
<b>DIA-TR222-80</b>	TRANSITION PROFILE - SATIN ANODIZED: 8MM (5/16")	\$16.50 EA
<b>DIA-TR222-100</b>	TRANSITION PROFILE - SATIN ANODIZED: 10MM (3/8")	\$17.85 EA
<b>DIA-TR222-125</b>	TRANSITION PROFILE - SATIN ANODIZED: 12.5MM (1/2")	\$21.50 EA
<b>DIA-TR850-80</b>	TRANSITION PROFILE - SATIN NICKEL ANODIZED: 8MM (5/16")	\$17.25 EA
<b>DIA-TR850-100</b>	TRANSITION PROFILE - SATIN NICKEL ANODIZED: 10MM (3/8")	\$18.95 EA
<b>DIA-TR850-125</b>	TRANSITION PROFILE - SATIN NICKEL ANODIZED: 12.5MM (1/2")	\$22.50 EA

Coming really handy when renovating, these transition profiles are conceived to realize a slope of 30 degrees between a ceramic surface and another surface of an inferior level by creating a smooth transition. Also ideal for transitions from ceramic tile coverings to finished surface. An angle of 90 degrees at the end of the slope will allow the meeting with a thinner revetment: like a carpet, a wood floor or a vinyl surface.

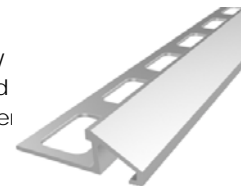

# DIAPLAS TILE TRIM

CALGARY & EDMONTON BRANCHES ONLY

## ROUND TRANSITION PROFILES

REVISION: MARCH 2019

Website: [www.eurotile.ca](http://www.eurotile.ca)

### ROUND TRANSITION PROFILES

SUGGESTED  
LIST PRICE

**DIA-RD223-80** ROUND TRANSITION PROFILE - BRIGHT ANODIZED: 8MM (5/16")  
**DIA-RD223-100** ROUND TRANSITION PROFILE - BRIGHT ANODIZED: 10MM (3/8")

**\$17.50 EA**  
**\$18.50 EA**

Coming really handy when renovating, or working on any other ceramic tile installations project, our rounded transition mouldings are conceived to realize a bullnose effect between a ceramic surface and another surface of an inferior level. These quarter circle trims are an outstanding protective and decorative edge for wall and countertop tile applications.

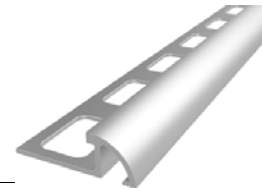

**DIA-ECRD222-80** ECONOMY ROUND TRANSITION PROFILE - SATIN ANODIZED: 8MM (5/16")  
**DIA-ECRD222-100** ECONOMY ROUND TRANSITION PROFILE - SATIN ANODIZED: 10MM (3/8")  
**DIA-ECRD222-125** ECONOMY ROUND TRANSITION PROFILE - SATIN ANODIZED: 12.5MM (1/2")

**\$11.70 EA**  
**\$13.40 EA**  
**\$14.50 EA**

It is used for outside corners of tiles to complete the appearance of wall coverings, flooring steps, bathtubs, etc. for a fraction of the price of the regular satin anodized rounded profiles. This extrusion has been designed thinner than our regular rounded range to reduce its cost.



# SCHLUTER SHOWER

BURNABY BRANCH ONLY

KERDI SHOWER KIT

REVISION: MARCH 2019

Website: [www.eurotile.ca](http://www.eurotile.ca)

## KERDI SHOWER KIT [KERDI-DRAIN GRATES ARE REQUIRED, AND SOLD SEPARATELY]

SUGGESTED  
LIST PRICE

**SC-KSK9651525ABS**  
**SC-KSK9651525SABS**

SHOWER KIT- 38"x60" CENTER DRAIN [ABS FLANGE]  
SHOWER KIT- 38"x60" OFFSET DRAIN [ABS FLANGE]

**\$572.88 EA**  
**\$572.88 EA**

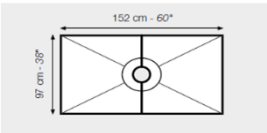

**KIT INCLUDES THE FOLLOWING MATERIAL:**

- 1 x KERDI-SHOWER-T/-TS/-TT Shower Tray
- 2 x KERDI-SHOWER-SC Shower Curb 38"x6"4-1/2"
- 1 x KERDI 10 M Waterproofing membrane 3'3"x33'=108ft
- 1 x KERDI-BAND Waterproofing strip 5"x33'
- 1 x KERDI-DRAIN-FLANGE, ABS Flange w/2" (50 mm) outlet
- 4 x KERDI-KERECK-F Preformed waterproofing inside corners
- 2 x KERDI-KERECK-F Preformed waterproofing outside corners
- 1 x KERDI-SEAL-PS Pipe seal (3/4" - 20 mm)
- 1 x KERDI-SEAL-MV Mixing valve seal

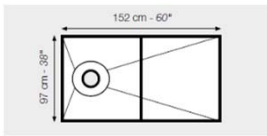

**SC-KSK1220ABS**

SHOWER KIT- 48"x48" CENTER DRAIN [ABS FLANGE]

**\$526.97 EA**

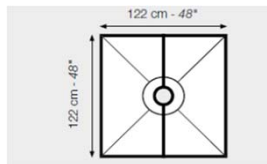

**KIT INCLUDES THE FOLLOWING MATERIAL:**

- 1 x KERDI-SHOWER-T/-TS/-TT Shower Tray
- 1 x KERDI-SHOWER-SC Shower Curb 48"x6"x4-1/2"
- 1 x KERDI 10 M Waterproofing membrane 3'3"x33'=108ft
- 1 x KERDI-BAND Waterproofing strip 5"x33'
- 1 x KERDI-DRAIN-FLANGE, ABS Flange w/2" (50 mm) outlet
- 4 x KERDI-KERECK-F Preformed waterproofing inside corners
- 2 x KERDI-KERECK-F Preformed waterproofing outside corners
- 1 x KERDI-SEAL-PS Pipe seal (3/4" - 20 mm)
- 1 x KERDI-SEAL-MV Mixing valve seal

**SC-KSK12201830ABS**  
**SC-KSK12201830PVC**

SHOWER KIT- 48"x72" CENTER DRAIN [ABS FLANGE]  
SHOWER KIT- 48"x72" CENTER DRAIN [PVC FLANGE]

**\$782.54 EA**  
**\$782.54 EA**



**KIT INCLUDES THE FOLLOWING MATERIAL:**

- 1 x KERDI-SHOWER-T/-TS/-TT Shower Tray
- 2 x KERDI-SHOWER-SC Shower Curb 38"x6"4-1/2"
- 1 x KERDI 12 M Waterproofing membrane 3'3"x39'4"=128ft
- 2 x KERDI-BAND Waterproofing strip 5"x33'
- 1 x KERDI-DRAIN-FLANGE, ABS OR PVC Flange w/2" (50 mm) outlet
- 4 x KERDI-KERECK-F Preformed waterproofing inside corners
- 2 x KERDI-KERECK-F Preformed waterproofing outside corners
- 1 x KERDI-SEAL-PS Pipe seal (3/4" - 20 mm)
- 1 x KERDI-SEAL-MV Mixing valve seal

**SC-KSK1830ABS**

SHOWER KIT- 72"x72" CENTER DRAIN [ABS FLANGE]

**\$969.52 EA**

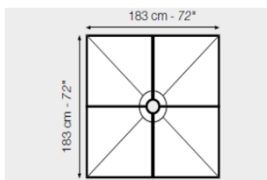

**KIT INCLUDES THE FOLLOWING MATERIAL:**

- 1 x KERDI-SHOWER-T/-TS/-TT Shower Tray
- 2 x KERDI-SHOWER-SC Shower Curb 38"x6"4-1/2"
- 1 x KERDI 5 M Waterproofing membrane 3'3"x16'5"=54ft
- 1 x KERDI 10 M Waterproofing membrane 3'3"x33'=108ft
- 2 x KERDI-BAND Waterproofing strip 5"x33'
- 1 x KERDI-DRAIN-FLANGE, ABS Flange w/2" (50 mm) outlet
- 4 x KERDI-KERECK-F Preformed waterproofing inside corners
- 2 x KERDI-KERECK-F Preformed waterproofing outside corners
- 1 x KERDI-SEAL-PS Pipe seal (3/4" - 20 mm)
- 1 x KERDI-SEAL-MV Mixing valve seal

# SCHLUTER SHOWER

BURNABY BRANCH ONLY

## KERDI DRAIN - FLANGE KITS

REVISION: MARCH 2019

Website: [www.eurotile.ca](http://www.eurotile.ca)

### KERDI DRAIN - FLANGE KITS

SUGGESTED  
LIST PRICE

SC-KD2FLKABS

KERDI DRAIN ABS FLANGE KIT - 2"

\$74.88 EA



ABS

**EACH KIT INCLUDES THE FOLLOWING MATERIAL:**

- 4 x Kerdi Inside Corners
- 2 x Kerdi Outside Corners
- 1 x 3/4" (20mm) Kerdi Pipe Seal
- 1 x 4-1/2" (114mm) Kerdi Mixing Valve Seal

Kerdi-Drain-Style Grates are sold separately, **please use with 4" (100mm) Grates.**

We recommend referring to the Schluter Catalogue for full details and to look at complete specs and compatibility requirements.

SC-KD2FLKABS10

KERDI DRAIN ABS FLANGE KIT - 2" [10 PACK]

\$673.92 EA



ABS

**EACH KIT INCLUDES THE FOLLOWING MATERIAL:**

- 10/Kit Pack - Comes In Bulk as NOT individually packed
- Comes with:
  - 40 x Kerdi Inside Corners
  - 20 x Kerdi Outside Corners
  - 10 x 3/4" (20mm) Kerdi Pipe Seal
  - 10 x 4-1/2" (114mm) Kerdi Mixing Valve Seal

Kerdi-Drain-Style Grates are sold separately, **please use with 4" (100mm) Grates.**

SC-KD3FLKABS

KERDI DRAIN ABS FLANGE KIT - 3"

\$84.12 EA



ABS

**EACH KIT INCLUDES THE FOLLOWING MATERIAL:**

- 4 x Kerdi Inside Corners
- 2 x Kerdi Outside Corners
- 1 x 3/4" (20mm) Kerdi Pipe Seal
- 1 x 4-1/2" (114mm) Kerdi Mixing Valve Seal

Kerdi-Drain-Style Grates are sold separately, **please use with 6" (150mm) Grates.**

We recommend referring to the Schluter Catalogue for full details and to look at complete specs and compatibility requirements.

# SCHLUTER SHOWER

BURNABY BRANCH ONLY

KERDI DRAIN - GRATE KITS

REVISION: MARCH 2019

Website: [www.eurotile.ca](http://www.eurotile.ca)

## KERDI DRAIN - GRATE KITS

SUGGESTED  
LIST PRICE

### 4" GRATE KITS:

SC-KD4GRKE	KERDI DRAIN GRATE KIT - STAINLESS STEEL 4"	\$54.46 EA
SC-KD4GRKE10	KERDI DRAIN GRATE KIT - STAINLESS STEEL 4" [10 PACK]	\$490.14 EA
SC-KD4GRKEP	KERDI DRAIN GRATE KIT - CHROME 4"	\$54.46 EA
SC-KD4GRKAKGB	KERDI DRAIN GRATE KIT - BRUSHED COPPER 4"	\$65.80 EA
SC-KD4GRKAMGB	KERDI DRAIN GRATE KIT - BRUSHED BRASS 4"	\$65.80 EA
SC-KD4GRKATGB	KERDI DRAIN GRATE KIT - BRUSHED NICKEL 4"	\$65.80 EA



**EACH KIT INCLUDES THE FOLLOWING MATERIAL:**

- 1 x Grate and Frame
- 1 x Height adjustment collar
- 1 x Lateral adjustment ring

To be used with Kerdi-Drain 2" (50mm) Flange Kits or Kerdi-Shower-Kits that are sold with 2" (50mm) flanges, both are sold separately.

### SC-KD4GRKECS

KERDI DRAIN GRATE KIT - TILEABLE 4" \$54.46 EA



**EACH KIT INCLUDES THE FOLLOWING MATERIAL:**

- 1 x Tileable covering support
- 1 x Spacer
- 1 x Lateral adjustment ring

To be used with Kerdi-Drain 2" (50mm) Flange Kits or Kerdi-Shower-Kits that are sold with 2" (50mm) flanges, both are sold separately.

### 6" GRATE KITS:

SC-KD6GRKE KERDI DRAIN GRATE KIT - STAINLESS STEEL 6" \$63.38 EA



**EACH KIT INCLUDES THE FOLLOWING MATERIAL:**

- 1 x Grate and Frame with Integrated Height Adjustment Collar
- 1 x Lateral adjustment ring

To be used with Kerdi-Drain 2" (50mm) - or - 3" (75mm) Flange Kits and Kerdi-Shower-Kits that are sold with 2" (50mm) flanges, both are sold separately



# SCHLUTER SHOWER

BURNABY BRANCH ONLY

## KERDI LINE - CHANNEL BODIES

REVISION: MARCH 2019

Website: [www.eurotile.ca](http://www.eurotile.ca)

### KERDI LINE - CENTERED OUTLET CHANNEL BODIES

SUGGESTED  
LIST PRICE

SC-KL1V60E50	KERDI-LINE 20" CHANNEL BODY - CENTERED OUTLET	\$301.00 EA
SC-KL1V60E60	KERDI-LINE 24" CHANNEL BODY - CENTERED OUTLET	\$310.55 EA
SC-KL1V60E70	KERDI-LINE 28" CHANNEL BODY - CENTERED OUTLET	\$337.32 EA
SC-KL1V60E80	KERDI-LINE 32" CHANNEL BODY - CENTERED OUTLET	\$340.58 EA
SC-KL1V60E90	KERDI-LINE 35" CHANNEL BODY - CENTERED OUTLET	\$355.70 EA
SC-KL1V60E100	KERDI-LINE 39" CHANNEL BODY - CENTERED OUTLET	\$365.62 EA
SC-KL1V60E110	KERDI-LINE 43" CHANNEL BODY - CENTERED OUTLET	\$373.25 EA
SC-KL1V60E120	KERDI-LINE 47" CHANNEL BODY - CENTERED OUTLET	\$390.64 EA
SC-KL1V60E130	KERDI-LINE 51" CHANNEL BODY - CENTERED OUTLET	\$473.38 EA
SC-KL1V60E140	KERDI-LINE 55" CHANNEL BODY - CENTERED OUTLET	\$485.40 EA
SC-KL1V60E150	KERDI-LINE 59" CHANNEL BODY - CENTERED OUTLET	\$497.02 EA
SC-KL1V60E160	KERDI-LINE 63" CHANNEL BODY - CENTERED OUTLET	\$506.65 EA
SC-KL1V60E170	KERDI-LINE 67" CHANNEL BODY - CENTERED OUTLET	\$514.56 EA
SC-KL1V60E180	KERDI-LINE 71" CHANNEL BODY - CENTERED OUTLET	\$523.47 EA

The Schluter®-KERDI-LINE is a low profile linear floor drain specifically designed for bonded waterproofing assemblies. KERDI-LINE can be installed adjacent to walls or at intermediate locations in showers, wet rooms, and other applications that require waterproofing and drainage. The KERDI-LINE channel body is made of formed stainless steel and features a collar made of Schluter®-KERDI for a secure waterproof connection.

\*Does NOT come with KERDI-LINE Grate assembly, that is required and to be purchased separately.

Comes with:

- 1 x Channel Body
- 1 x Channel Support
- 1 x No-Hub Coupling
- 4 x KERDI Inside Corners
- 2 x KERDI Outside Corners
- 1 x KERDI Pipe Seal (3/4" - 20mm)
- 1 x KERDI Mixing Valve Seal (4-1/2" - 114mm)

### KERDI LINE - OFFSET OUTLET CHANNEL BODIES

SUGGESTED  
LIST PRICE

SC-KL1VO60E70	KERDI-LINE 28" CHANNEL BODY - OFFSET OUTLET	\$341.47 EA
SC-KL1VO60E80	KERDI-LINE 32" CHANNEL BODY - OFFSET OUTLET	\$344.78 EA
SC-KL1VO60E90	KERDI-LINE 35" CHANNEL BODY - OFFSET OUTLET	\$360.56 EA
SC-KL1VO60E100	KERDI-LINE 39" CHANNEL BODY - OFFSET OUTLET	\$383.82 EA
SC-KL1VO60E110	KERDI-LINE 43" CHANNEL BODY - OFFSET OUTLET	\$399.38 EA
SC-KL1VO60E120	KERDI-LINE 47" CHANNEL BODY - OFFSET OUTLET	\$418.34 EA

# SCHLUTER SHOWER

BURNABY BRANCH ONLY

## KERDI LINE - GRATE ASSEMBLIES

REVISION: MARCH 2019

Website: [www.eurotile.ca](http://www.eurotile.ca)

### KERDI LINE - GRATE ASSEMBLIES

SUGGESTED  
LIST PRICE

\*Note to be used with KERDI-LINE Channel bodies which are NOT included and sold seperately.

**CLOSED & PERFORATED GRATES WORK WITH BOTH CENTERED AND OFFSET CHANNEL BODIES**

Grate Assembly – Brushed Stainless Steel

3/4" (19mm) Frame Height for 1/8" to 9/16" (3mm to 15mm) thick coverings

Comes With:

1 x Closed-Design Grate

1 x Grate Frame w/Height Adjustment Spacer

SC-KL1AR19EB50	KERDI-LINE 20" CLOSED GRATE		\$279.83 EA
SC-KL1AR19EB60	KERDI-LINE 24" CLOSED GRATE		\$287.84 EA
SC-KL1AR19EB70	KERDI-LINE 28" CLOSED GRATE		\$299.67 EA
SC-KL1AR19EB80	KERDI-LINE 32" CLOSED GRATE		\$307.42 EA
SC-KL1AR19EB90	KERDI-LINE 35" CLOSED GRATE		\$321.87 EA
SC-KL1AR19EB100	KERDI-LINE 39" CLOSED GRATE		\$341.13 EA
SC-KL1AR19EB110	KERDI-LINE 43" CLOSED GRATE		\$349.50 EA
SC-KL1AR19EB120	KERDI-LINE 47" CLOSED GRATE		\$355.83 EA
SC-KL1AR19EB130	KERDI-LINE 51" CLOSED GRATE		\$463.92 EA
SC-KL1AR19EB140	KERDI-LINE 55" CLOSED GRATE		\$487.17 EA
SC-KL1AR19EB150	KERDI-LINE 59" CLOSED GRATE		\$512.70 EA
SC-KL1AR19EB160	KERDI-LINE 63" CLOSED GRATE		\$545.86 EA
SC-KL1AR19EB170	KERDI-LINE 67" CLOSED GRATE		\$569.10 EA
SC-KL1AR19EB180	KERDI-LINE 71" CLOSED GRATE		\$601.70 EA

SC-KL1B19EB50	KERDI-LINE 20" PERFORATED GRATE		\$254.65 EA
SC-KL1B19EB60	KERDI-LINE 24" PERFORATED GRATE		\$259.51 EA
SC-KL1B19EB70	KERDI-LINE 28" PERFORATED GRATE		\$273.85 EA
SC-KL1B19EB80	KERDI-LINE 32" PERFORATED GRATE		\$278.83 EA
SC-KL1B19EB90	KERDI-LINE 35" PERFORATED GRATE		\$294.01 EA
SC-KL1B19EB100	KERDI-LINE 39" PERFORATED GRATE		\$302.50 EA
SC-KL1B19EB110	KERDI-LINE 43" PERFORATED GRATE		\$313.33 EA
SC-KL1B19EB120	KERDI-LINE 47" PERFORATED GRATE		\$319.28 EA
SC-KL1B19EB130	KERDI-LINE 51" PERFORATED GRATE		\$463.92 EA
SC-KL1B19EB140	KERDI-LINE 55" PERFORATED GRATE		\$487.17 EA
SC-KL1B19EB150	KERDI-LINE 59" PERFORATED GRATE		\$512.70 EA
SC-KL1B19EB160	KERDI-LINE 63" PERFORATED GRATE		\$545.86 EA
SC-KL1B19EB170	KERDI-LINE 67" PERFORATED GRATE		\$569.10 EA
SC-KL1B19EB180	KERDI-LINE 71" PERFORATED GRATE		\$601.70 EA

**TILEABLE GRATES BELOW FOR USE WITH CENTER OUTLET CHANNEL BODIES:**

SC-KL1DRE50	KERDI-LINE 20" TILEABLE GRATE		\$129.56 EA
SC-KL1DRE60	KERDI-LINE 24" TILEABLE GRATE		\$135.86 EA
SC-KL1DRE70	KERDI-LINE 28" TILEABLE GRATE		\$142.16 EA
SC-KL1DRE80	KERDI-LINE 32" TILEABLE GRATE		\$148.46 EA
SC-KL1DRE90	KERDI-LINE 35" TILEABLE GRATE		\$159.17 EA
SC-KL1DRE100	KERDI-LINE 39" TILEABLE GRATE		\$177.03 EA
SC-KL1DRE110	KERDI-LINE 43" TILEABLE GRATE		\$183.29 EA
SC-KL1DRE120	KERDI-LINE 47" TILEABLE GRATE		\$189.54 EA
SC-KL1DRE130	KERDI-LINE 51" TILEABLE GRATE		\$228.56 EA
SC-KL1DRE140	KERDI-LINE 55" TILEABLE GRATE		\$230.52 EA
SC-KL1DRE150	KERDI-LINE 59" TILEABLE GRATE		\$232.88 EA
SC-KL1DRE160	KERDI-LINE 63" TILEABLE GRATE		\$255.80 EA
SC-KL1DRE170	KERDI-LINE 67" TILEABLE GRATE		\$258.32 EA
SC-KL1DRE180	KERDI-LINE 71" TILEABLE GRATE		\$260.44 EA

# SCHLUTER SHOWER

BURNABY BRANCH ONLY

## KERDI LINE - GRATE ASSEMBLIES & SHOWER LT/LTS

REVISION: MARCH 2019

Website: [www.eurotile.ca](http://www.eurotile.ca)

### KERDI LINE - GRATE ASSEMBLIES CONT'D

#### TILEABLE GRATES BELOW FOR USE WITH OFFSET OUTLET CHANNEL BODIES:

SC-KL1DROE70	KERDI-LINE 28" TILEABLE GRATE - OFFSET
SC-KL1DROE80	KERDI-LINE 32" TILEABLE GRATE - OFFSET
SC-KL1DROE90	KERDI-LINE 35" TILEABLE GRATE - OFFSET
SC-KL1DROE100	KERDI-LINE 39" TILEABLE GRATE - OFFSET
SC-KL1DROE110	KERDI-LINE 43" TILEABLE GRATE - OFFSET
SC-KL1DROE120	KERDI-LINE 47" TILEABLE GRATE - OFFSET

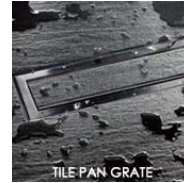

SUGGESTED LIST PRICE

\$142.16 EA
\$148.46 EA
\$159.17 EA
\$177.03 EA
\$183.29 EA
\$189.54 EA

### KERDI SHOWER - T [TRAY W/CENTER DRAIN PLACEMENT]

SC-KST965/1525	KERDI SHOWER T TRAY - 38x60 [FOR CENTER DRAIN]
SC-KST1220/1525	KERDI SHOWER T TRAY - 48x60 [FOR CENTER DRAIN]
SC-KST1220/1830	KERDI SHOWER T TRAY - 48x72 [FOR CENTER DRAIN]
SC-KST1525	KERDI SHOWER T TRAY - 60x60 [FOR CENTER DRAIN]
SC-KST1830	KERDI SHOWER T TRAY - 72x72 [FOR CENTER DRAIN]

SUGGESTED LIST PRICE

\$150.00 EA
\$227.50 EA
\$215.65 EA
\$299.00 EA
\$312.50 EA

### KERDI SHOWER - LT [TRAY W/CENTER LINEAR DRAIN PLACEMENT]

Schluter®-KERDI-SHOWER-LT/-LTS are polystyrene sloped trays with integrated Schluter®-KERDI waterproofing. Each of these prefabricated shower trays is designed to integrate with the Schluter®-KERDI-LINE. The KERDI-SHOWER-LT allows for the installation of a center drain.

For use with Kerdi-Line Channel Bodies and Grates which are sold separately

SC-KSLT1000	KERDI SHOWER LT TRAY - 39x39 [FOR CENTER DRAIN]
SC-KSLT1220	KERDI SHOWER LT TRAY - 48x48 [FOR CENTER DRAIN]
SC-KSLT1395	KERDI SHOWER LT TRAY - 55x55 [FOR CENTER DRAIN]

SUGGESTED LIST PRICE

\$187.50 EA
\$250.00 EA
\$315.00 EA

### KERDI SHOWER - LTS [TRAY W/PERIMETER LINEAR DRAIN PLACEMENT]

SC-KSLT1000S	KERDI SHOWER LTS TRAY - 39x39 [FOR PERIMETER DRAIN]
SC-KSLT915/1395S	KERDI SHOWER LTS TRAY - 36x55 [FOR PERIMETER DRAIN]
SC-KSLT915/1830S	KERDI SHOWER LTS TRAY - 36x72 [FOR PERIMETER DRAIN]
SC-KSLT1395S	KERDI SHOWER LTS TRAY - 55x55 [FOR PERIMETER DRAIN]
SC-KSLT965/1930S	KERDI SHOWER LTS TRAY - 38x76 [FOR PERIMETER DRAIN] *SHORT SIDE
SC-KSLT1930/965S	KERDI SHOWER LTS TRAY - 38x76 [FOR PERIMETER DRAIN] *LONG SIDE

SUGGESTED LIST PRICE

\$187.50 EA
\$286.00 EA
\$295.00 EA
\$315.00 EA
\$325.00 EA
\$325.00 EA

### KERDI SHOWER CURB

SC-KBSC1151501220	SHOWER CURB MADE W/ KERDI BOARD- 48" x 6" x 4.5"
-------------------	--

SUGGESTED LIST PRICE

\$75.00 EA
------------

Schluter®-KERDI-BOARD-SC is a prefabricated shower curb made of KERDI-BOARD that is designed to integrate with the Schluter®-Shower System. The curb is lightweight, stable, and load bearing. It can be used in conjunction with the KERDI-SHOWER prefabricated shower trays as well as in mortar bed applications. KERDI-BOARD-SC is quick and easy to install, waterproof and ready to tile, making it a simple solution for tiled shower curbs.

# BATH & SHOWER ACCESSORIES

BURNABY BRANCH ONLY

## SCHLUTER KERDI BOARD SHOWER BENCHES

REVISION: MARCH 2019

Website: www.eurotile.ca

### KERDI BOARD SHOWER BENCHES

		PCS/BOX	LBS/BOX	SUGGESTED LIST PRICE
<b>SC-KBSB410TA</b>	TRIANGULAR BENCH - 16"W x 16"L x 20"H	N/A	5	<b>\$185.00 EA</b>
<b>SC-KBSB610TA</b>	TRIANGULAR BENCH - 24"W x 24"L x 20"H	N/A	5	<b>\$250.00 EA</b>
<b>SC-KBSB290970RA</b>	RECTANGULAR BENCH - 38"W x 11.5"L x 20"H	N/A	5	<b>\$310.00 EA</b>
<b>SC-KBSB4101220RA</b>	RECTANGULAR BENCH - 48"W x 16"L x 20"H	N/A	5	<b>\$409.00 EA</b>

Schluter®-KERDI-BOARD-SB is a lightweight, waterproof, prefabricated shower bench made of KERDI-BOARD that is designed to integrate with the Schluter®-Shower System.

The triangular bench includes preformed 135° KERDI-KERECK inside corners, as well as right and left KERDI-KERS-B bench corners to simplify waterproofing connections at the wall

The rectangular bench includes 2 of each preformed 90° inside and outside KERDI-KERECK corners to simplify waterproofing connections at the wall



### KERDI BOARD

		PCS/BOX	SUGGESTED LIST PRICE
<b>SC-KB5/1220/1625</b>	KERDI-BOARD 48"X64"X3/16"	N/A	<b>\$67.24 EA</b>
<b>SC-KB9/1220/1625</b>	KERDI-BOARD 48"X64"X3/8"	"	<b>\$70.53 EA</b>
<b>SC-KB12/1220/1625</b>	KERDI-BOARD 48"X64"X1/2"	"	<b>\$73.82 EA</b>
<b>SC-KB12/1220/2440</b>	KERDI-BOARD 48"X96"X1/2"	"	<b>\$110.71 EA</b>
<b>SC-KB19/625/2440</b>	KERDI-BOARD 24 - 1/2"X96"X3/4"	"	<b>\$60.52 EA</b>

Schluter-KERDI-BOARD is a multifunctional tile substrate and building panel, which can be used for creating bonded waterproofing assemblies with tile coverings. It consists of an extruded polystyrene foam panel, with a special reinforcement material on both sides and fleece webbing for effective anchoring in thin-set mortar. The boards are simply cut to size with a utility knife. The gridlines, which are printed on the surface, are helpful for neat and quick cuts and installation. Tiles can be installed directly over KERDI-BOARD using the thin-set method.



<b>SC-KBZT32Z</b>	ATTACHMENT WASHERS 1 - 1/4		100	<b>\$10.98 EA</b>
-------------------	----------------------------	---	-----	-------------------

Schluter-KERDI-BOARD-Z1 are galvanized steel washers, which are used to fasten Schluter-KERDI-BOARD to stud framing. They feature tabs that penetrate the surface of the KERDI-BOARD and temporarily hold the washers in place to enable quick installation of the corresponding screws.

<b>SC-KBZS35G</b>	COURSE THREAD SCREW 1 - 5/8		200	<b>\$14.98 EA</b>
<b>SC-KBZS55G</b>	COURSE THREAD SCREW 2		100	<b>\$10.98 EA</b>
<b>SC-KBZS75G</b>	COURSE THREAD SCREW 3		100	<b>\$16.76 EA</b>

Schluter-KERDI-BOARD-ZS are screws used to fasten Schluter-KERDI-BOARD to stud framing with the corresponding washers.

# BATH & SHOWER ACCESSORIES



BURNABY BRANCH ONLY

## SCHLUTER KERDI NICHE BATH/SHOWER SHELVING

REVISION: MARCH 2019

Website: [www.eurotile.ca](http://www.eurotile.ca)

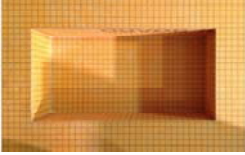
### KERDI NICHE BATH/SHOWER SHELVING

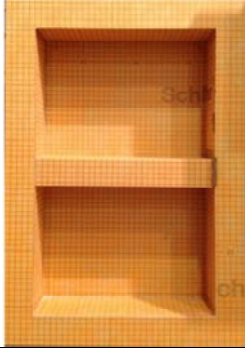
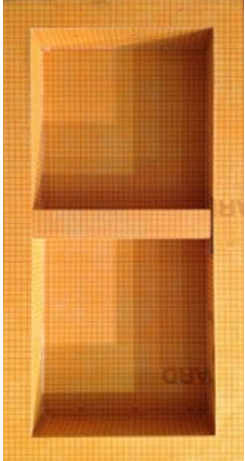
		PCS/BOX	LBS/BOX	SUGGESTED LIST PRICE
<b>SC-KB12SN305152A</b> 	KERDI-BOARD-SN NICHE 12"x6"  FACE: 16" x 10" BACK: 12" x 6" DEPTH: 4"	1	1.98	<b>\$56.96 EA</b>
<b>SC-KB12SN305305A</b> 	KERDI-BOARD-SN NICHE 12"x12"  FACE: 16"x16" BACK: 12"x12" DEPTH: 4"	1	2.38	<b>\$68.22 EA</b>
<b>SC-KB12SN305508A1</b> 	KERDI-BOARD-SN NICHE 12"x20"  FACE: 16"x24" BACK: 12"x20" DEPTH: 4"	1	3.62	<b>\$92.21 EA</b>
<b>SC-KB12SN305711A1</b> 	KERDI-BOARD-SN NICHE 12"x28"  FACE: 16"x32" BACK: 12"x28" DEPTH: 4"	1	4.4	<b>\$110.21 EA</b>